

Features

- Automatic Calibration
- Built in Temperature Compensation
- Adjustable Attenuation: 31.5dB Range,0.5dB Step Size
- Supply Voltage: 110V/220V AC



Typical Applications

- Microwave Radio and VSAT.
- Telecom Infrastructure.

Parameters	Min.	Typ.	Max.	Min.	Typ.	Max.	Units
Frequency Range	2		6				GHz
Gain	60	70					dB
Gain Flatness		±3.0	±5.0				dB
Gain Variation Over Temperature		±3.0	±5.0				dB
Input VSWR		1.5	2.0				: 1
Saturated Output Power (Psat)	49.5	50					dBm
IM3 2-Tone@ 37dBm/Tone, 1MHz Spacing	-25	-30					dBc
Isolation S12		-60	-50				dB
Supply Current (I _{dd}) (AC=220V)	1.76						A

Weight	1250 ounces (Max.)	Impedance	50ohms
Input / Output Connectors	Input: N-Female Output: N-Female	Material	Aluminum
Finish	Gray Painted	Power Supply Connector	D-SUB COMBO 3POS

Absolute Maximum Ratings

Operating Voltage	AC110~220V
RF Input Power(RFIN)	P _{sat} – Gain

Note: Maximum RF input power is defined to protect the amplifier from damage.

Input power may be increased at the users own risk to achieve the full output power of the amplifier. Please reference gain and power curves and monitor the temperature.

Biassing Up Procedure

Step 1	Connect input and output with 50 Ohm source and load with in band return loss better than 10dB.
Step 2	Connect AC Plug
Step 3	Flip switch to "ON" position

Power OFF Procedure

Step 1	Flip switch to "OFF" position
Step 2	Remove AC Plug
Step 3	Remove RF Connection

Environmental Specifications

Operational Temperature	-40°C~+85°C (Case Temperature below 85)
Storage Temperature	-50°C~+105°C
Altitude	30,000 ft. (Epoxy Sealed Controlled environment)
	60,000 ft. 1.0psi min (Hermetically Sealed Un-controlled environment) (Optional)
Vibration	25g RMS (15 degrees 2KHz) endurance, 1 hour per axis
Humidity	100% RH at 35°C, 95%RH at 40°C
Shock	20G for 11msec half sine wave,3 axis both directions

Outline Drawing:

All Dimensions in mm (inches)

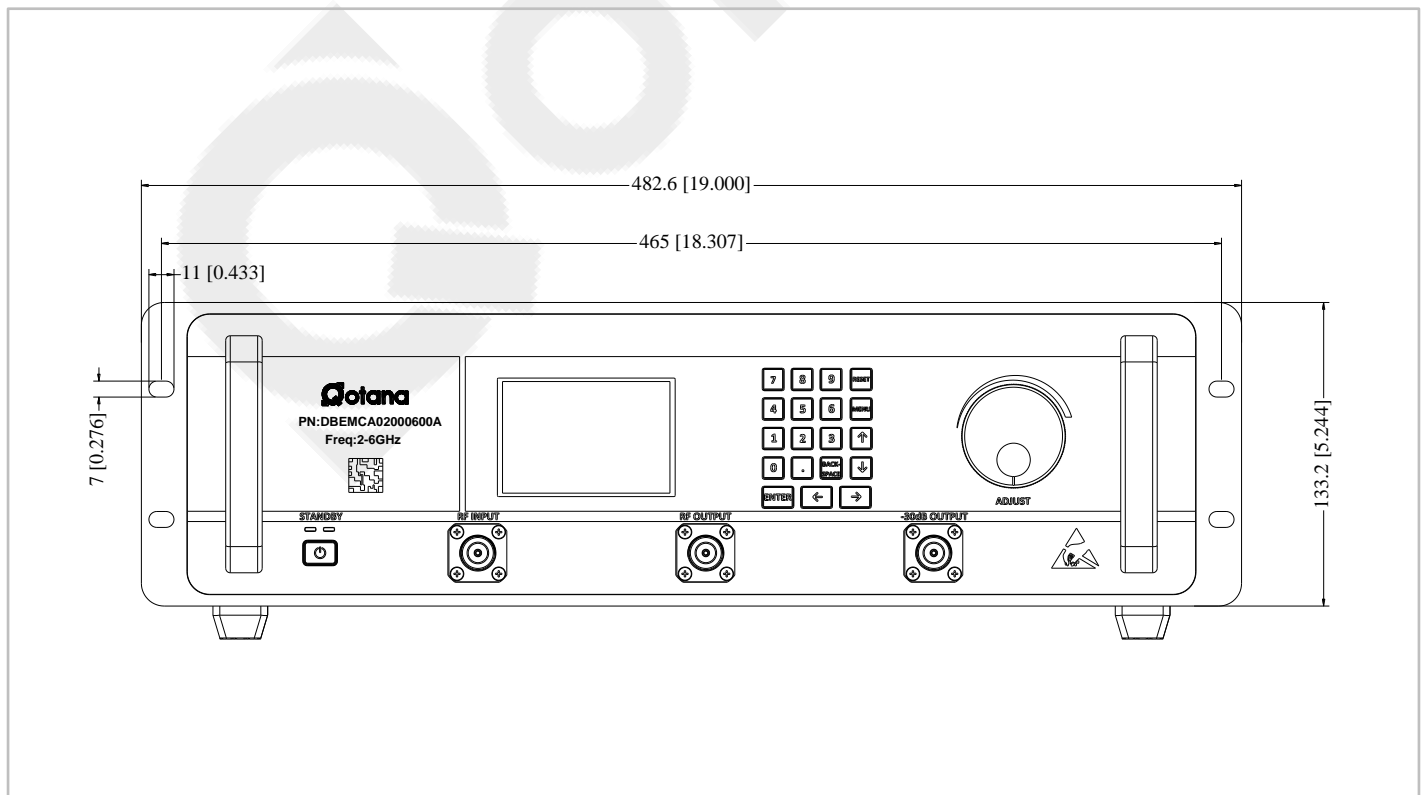

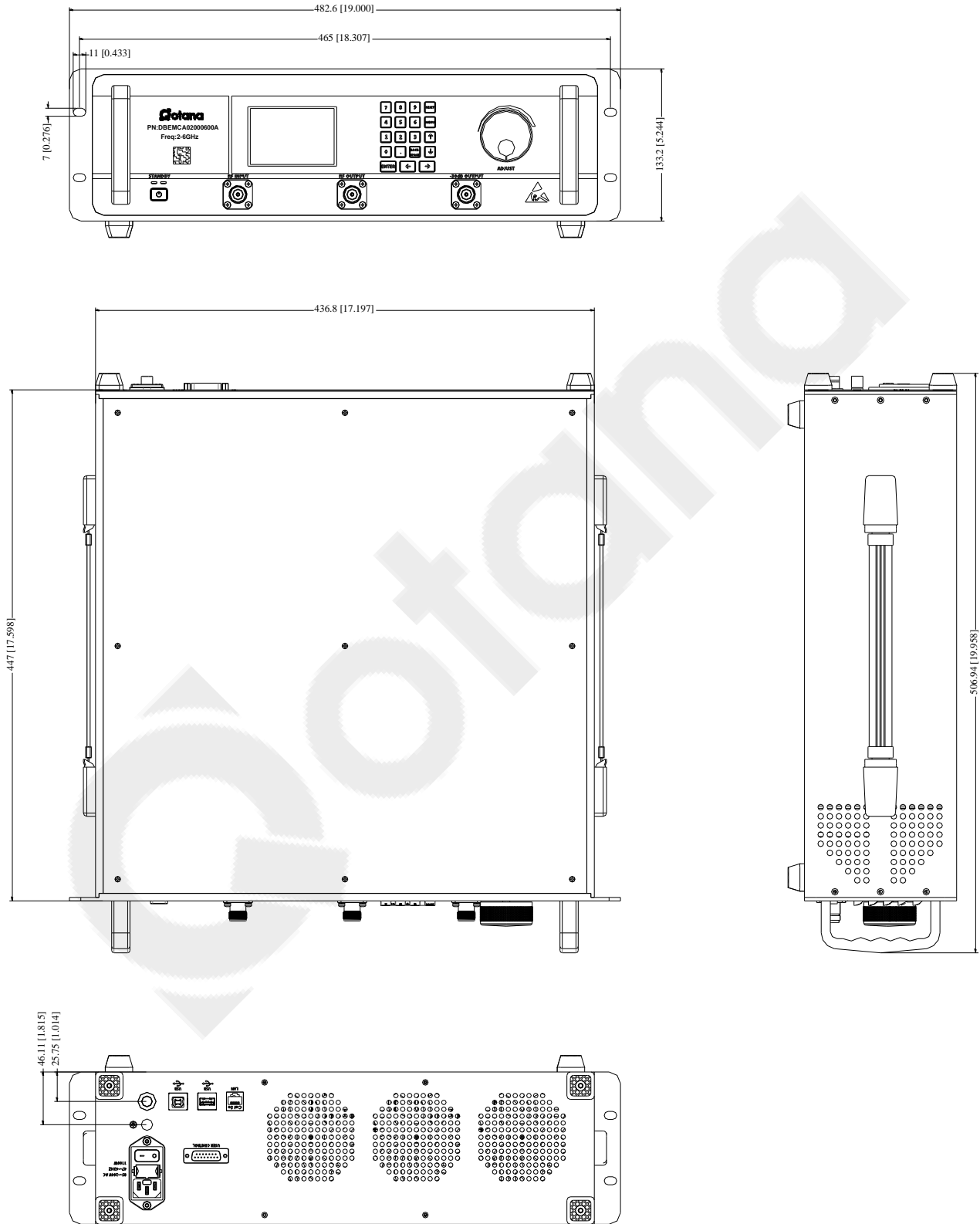

Gain @+25°C

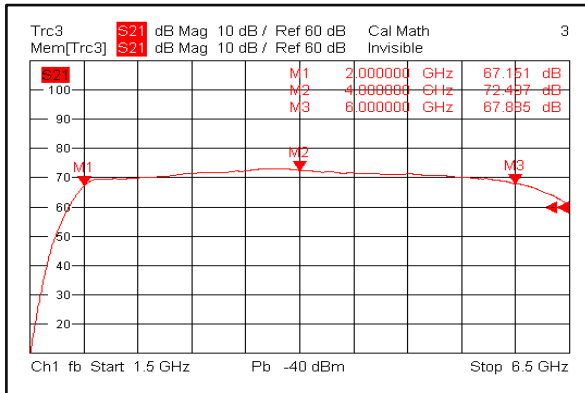

Input VSWR

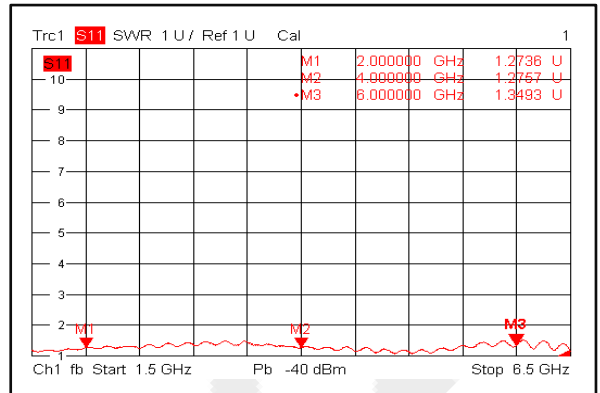

Isolation

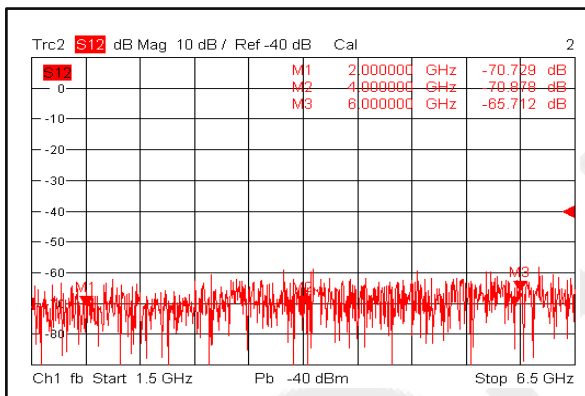

Gain vs. Output Power

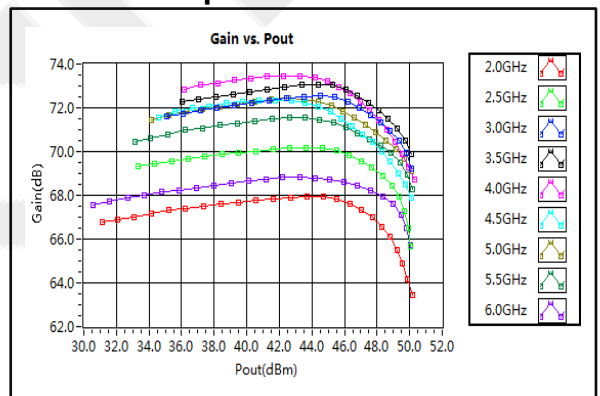

P1dB & P3dB & P5dB vs. Frequency

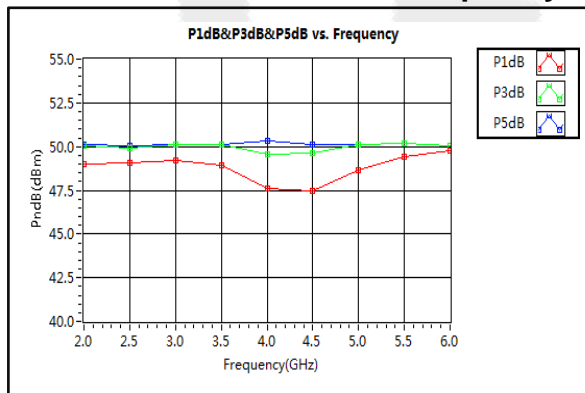

Saturation Power vs. Frequency

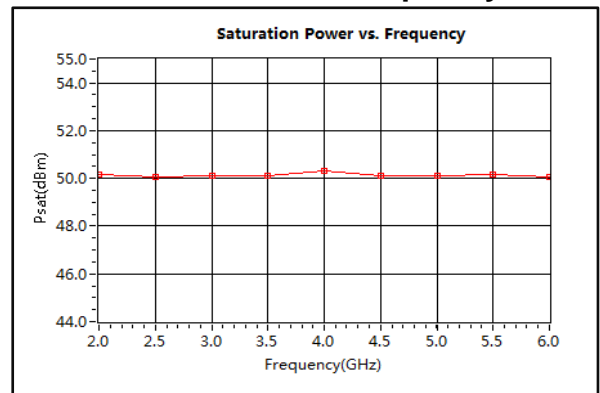

Left IM3 vs. Pout

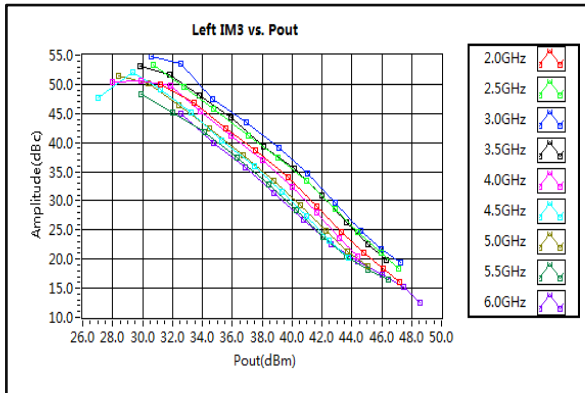

Right IM3 vs. Pout

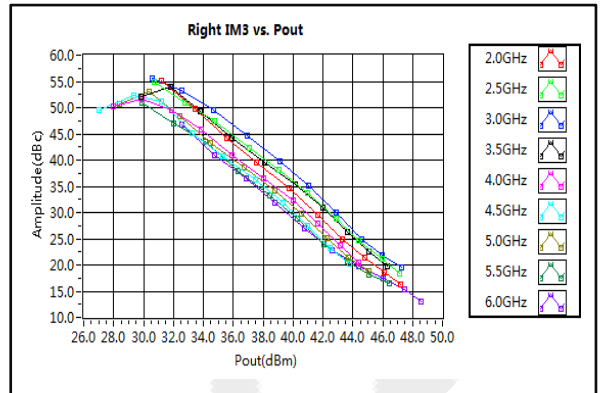

2nd Harmonic Wave Output Power

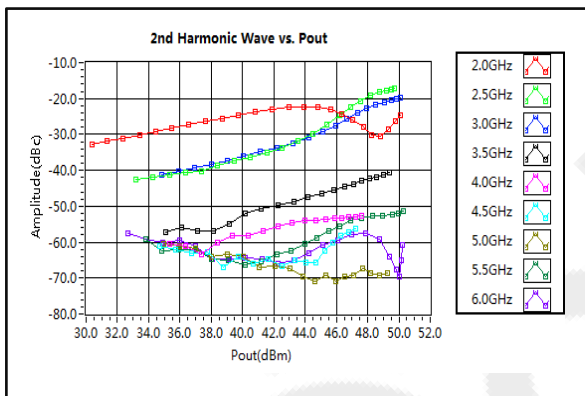

3rd Harmonic Wave Output Power

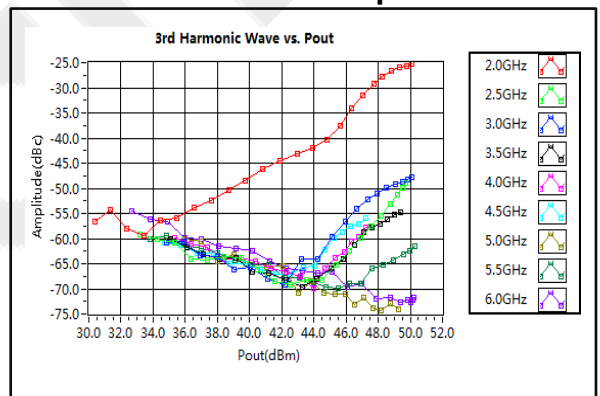

4th Harmonic Wave Output Power

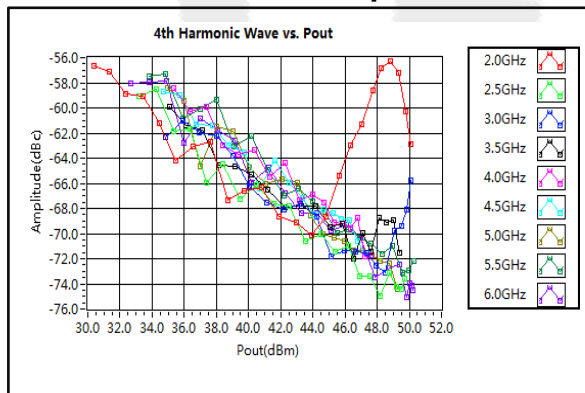

EMC Equipment User Manual

Front Panel

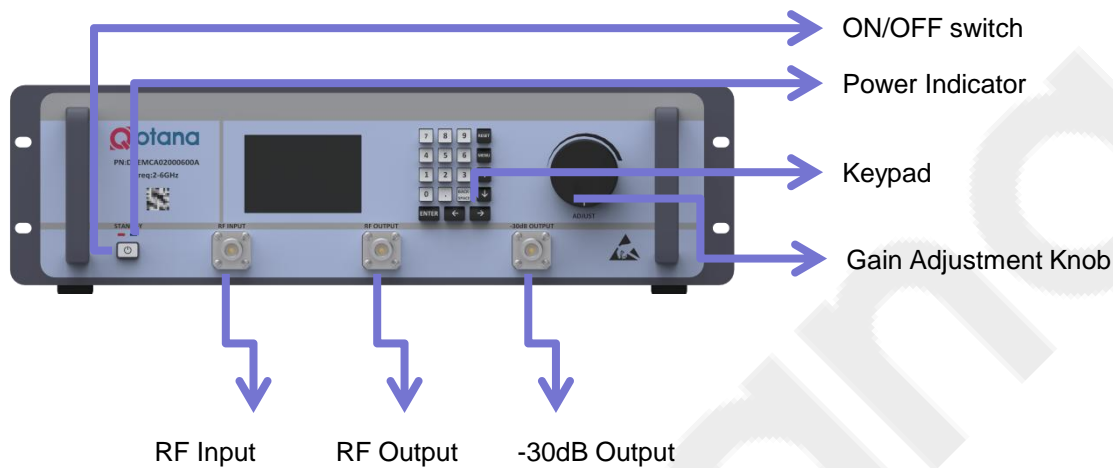

Rear Panel

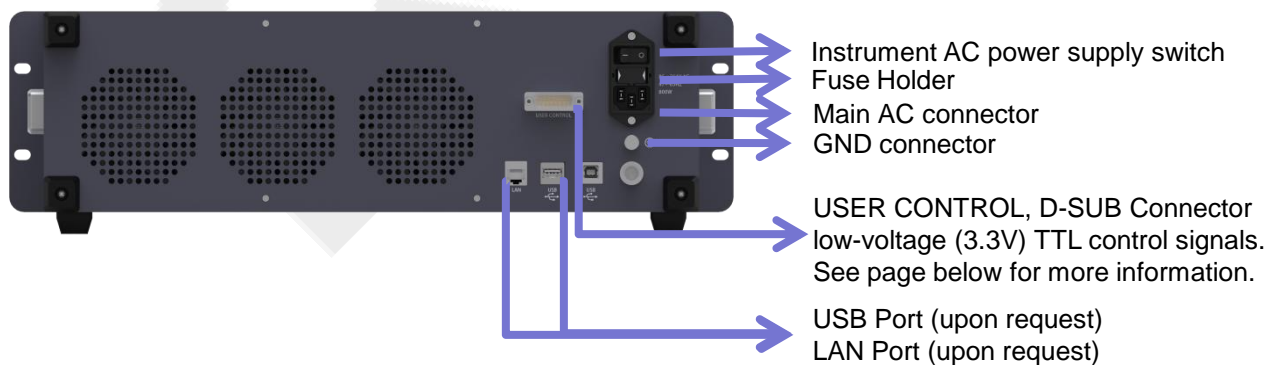

Front Panel LCD Screen Display

Switching On Instrument



Please follow the instructions on the front panel LCD screen after switching on the power. Press "1" on keypad to continue.

Self Calibration Screen

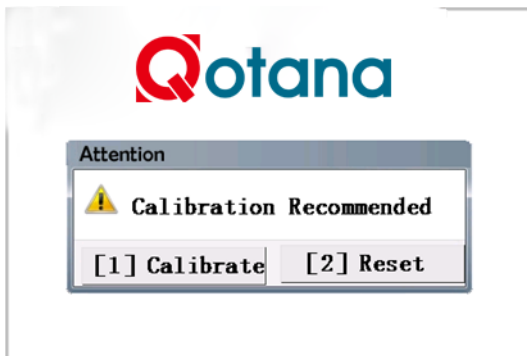

Calibration is may be recommended "[1] Calibrate" to execute instrument self calibration process.

"[2] Reset" to reboot the instrument.

*Please turn OFF RF input power, and terminate the RF output port while applying calibration function

Instrument Protection Alarms

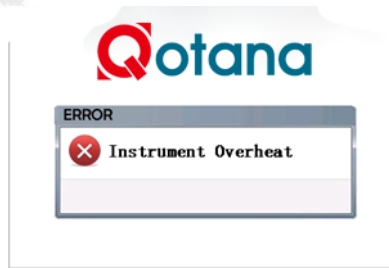
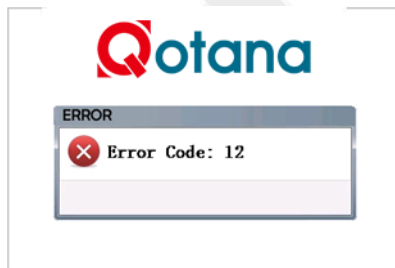

The front panel LCD screen will display the error code or error message when instrument self protection is triggered. Front panel alarm indicator will light up.

To eliminate the error code, press "RESET" on front panel keypad to reboot the instrument and clear the alarms.

If error code can not be eliminated after reboot, please contact sales@qotana.com

Instrument Status Display Page

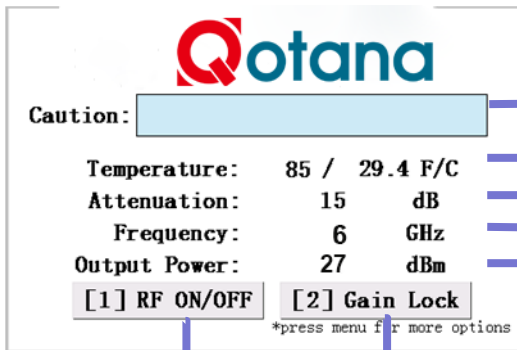

Indicates instrument RF output status. It will display:
Output is Ready to Turn on or RF Output is ON

Instrument temperature

RF output attenuation (change with adjustment knob)

RF input signal center frequency

Instrument RF output power

Press "Menu" on keypad to enter instrument functions selection menu

User can set a constant gain for the unit. Equipment will automatically adjust the gain at certain frequency

Switches On or Off for instrument RF output port

Instrument Function Selection Page

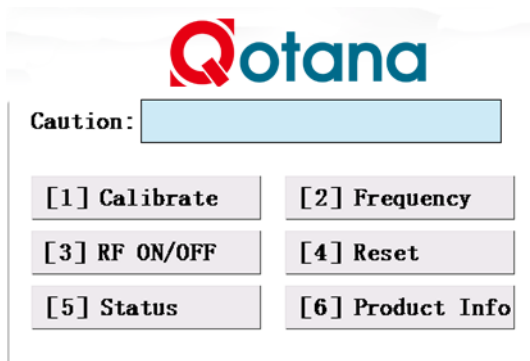

To enter this function selection page, press "Menu" on front panel keypad while the instrument is showing the status page. Press the corresponding number on front panel keypad to select:

"[1] Calibrate" calibrates the instruments.

"[2] Frequency" enters RF input signal center frequency.

"[3] RF ON/OFF" switches the RF output port on or off.

"[4] Reset" Restarts the instrument (Turns RF output off)

"[5] Status" enters instrument status display page.

"[6] Product Info" displays product part number and serial number

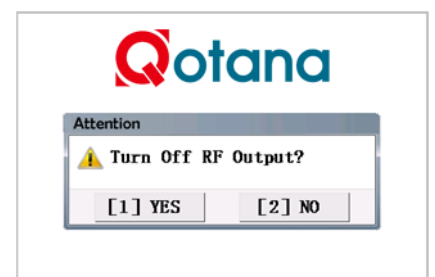
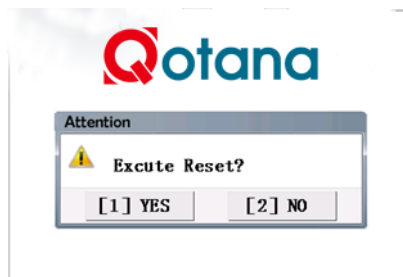
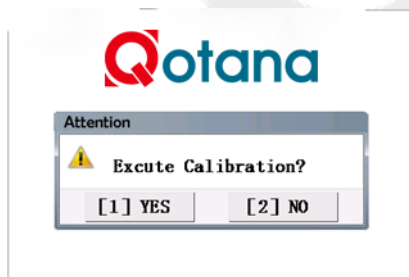

All action functions will ask for confirming execution when selected from function selection menu.

User Control Connector on Rear Panel

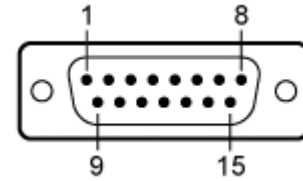

Pin #	Name	Function	Initial State	Description	Applied
1	Reset	Control		Resets PA when logic <u>LOW</u> is applied and released	Yes
2	Driver Disable	Control	LOW	Applying logic <u>HIGH</u> disables driver of amplifiers	Yes
3	Drain Disable	Control	LOW	Applying logic <u>HIGH</u> disables drain of amplifiers	Yes
4	RF IN Over	Indicator	LOW	Pin will be latched to logic <u>HIGH</u> when input signal is over limit	No
5	Temp Over	Indicator	LOW	Pin will be latched to logic <u>HIGH</u> when amplifier is driven over temperature	Yes
6	Current Over	Indicator	LOW	Pin will be latched to logic <u>HIGH</u> when drain current limit is reached	Yes
7	ID Imbalance	Indicator	LOW	Pin will be latched to logic <u>HIGH</u> when an imbalance in the drain current of the combining branches occurs	Yes
8	PA input power	Indicator		PA input power is represented by voltage	No
9	PA output power	Indicator		PA output power is represented by voltage	No
10	PA output reflection power	Indicator		PA output reflection power is represented by voltage	No
11	VSWR	Indicator	LOW	Pin will be latched to logic <u>HIGH</u> when output reflection is over limit	No
13	+5V	Power Supply	+5V	+5V DC is supplied for reference	Yes
14	GND	Ground	GND	Ground	Yes
15	GND	Ground	GND	Ground	Yes

HIGH/LOW voltages are standard TTL signals:
0.0V-0.8V = LOW
2V-5V = HIGH